



Sandia
National
Laboratories

Energy Storage Overview



Southern Research, April 5, 2022

Howard Passell, Ph.D.
Energy Storage Systems Policy & Outreach Program
Sandia National Laboratories



Sandia National Laboratories is a multimission laboratory managed and operated by National Technology & Engineering Solutions of Sandia, LLC, a wholly owned subsidiary of Honeywell International Inc., for the U.S. Department of Energy's National Nuclear Security Administration under contract DE-NA0003525.

SAND2021-3338 TR

SNL Outreach to Regulators



Sandia is funded by the Energy Storage (ES) Programs Office in the DOE Office of Electricity to provide outreach to regulatory commissions around the U.S.

In collaboration with PNNL and other institutions . . .

FEMA & ISU Microgrids & ES Webinar Series, ongoing

Wisconsin PSC Webinar Series, April-July, 2021

NECPUC ES Webinar Series, Mar.-June 2021

New Jersey BPU ES Webinar Series, Jan.-Mar. 2021

Iowa State Univ./MISO ES Webinar Series, July-Oct. 2020

Utah Governor's Office of Energy Development Webinar Series, July-Aug. 2020

Maryland PSC Webinar Series, Mar.-Apr. 2020

Nevada PUC Workshop, Jan. 2020

Southeast Energy Storage Symposium & PUC Workshop (with Southern Research)

New Mexico PRC workshops/webinars, 2019 & 2020 and ongoing

California Energy Commission (CEC), June 14, 2019, Sacramento: Energy Storage Academy

Hawaii PUC, Dec. 7, 2018, Honolulu: ES Introductory Workshop



Kentucky Public Service Commission





U.S. annual energy storage market size, 2012-2026E (million \$)

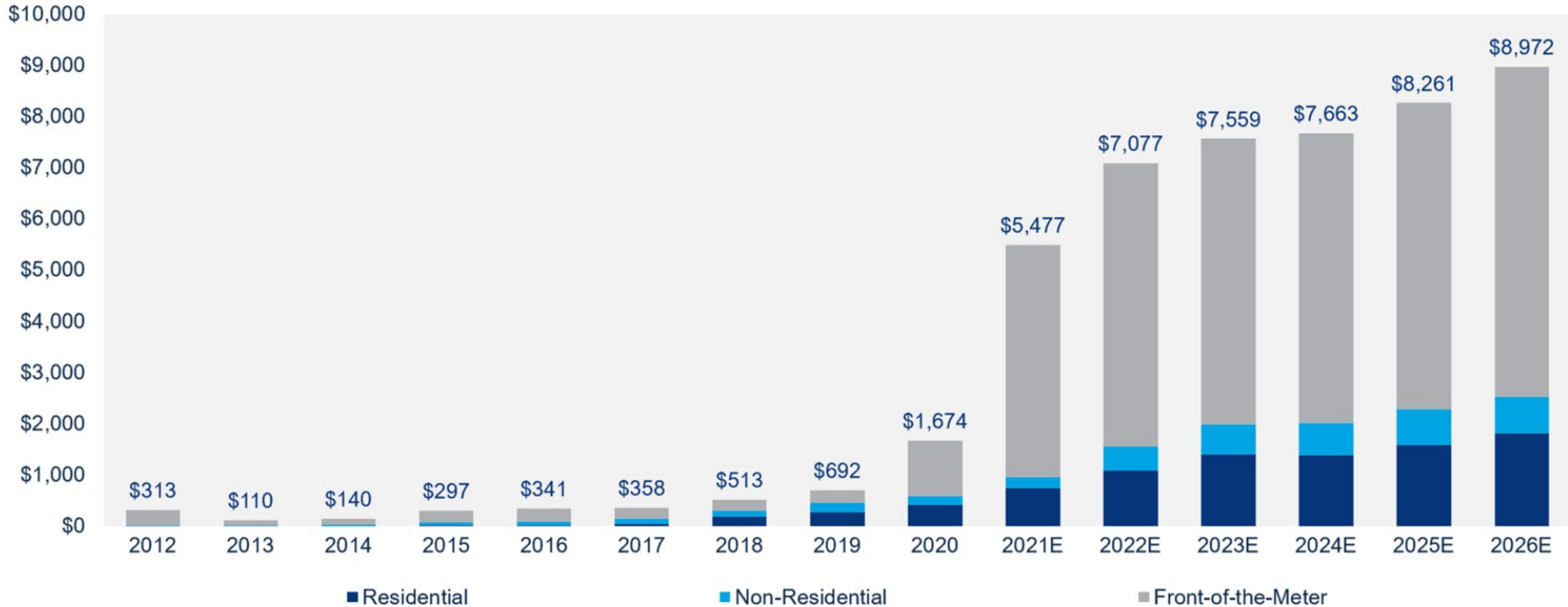

Why Energy Storage? The CA Duck Curve

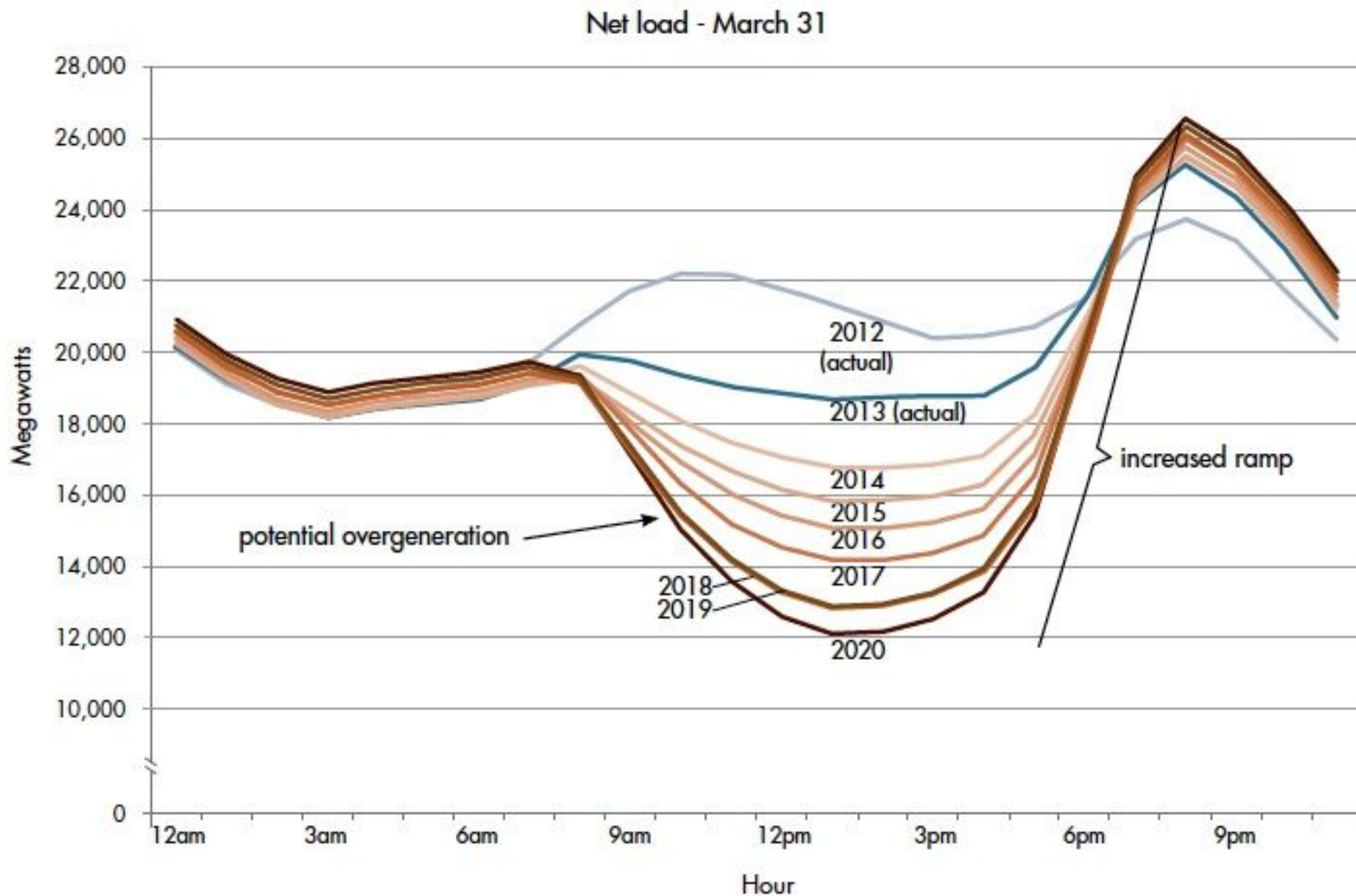

Why Energy Storage? Peak demand & Energy Variability

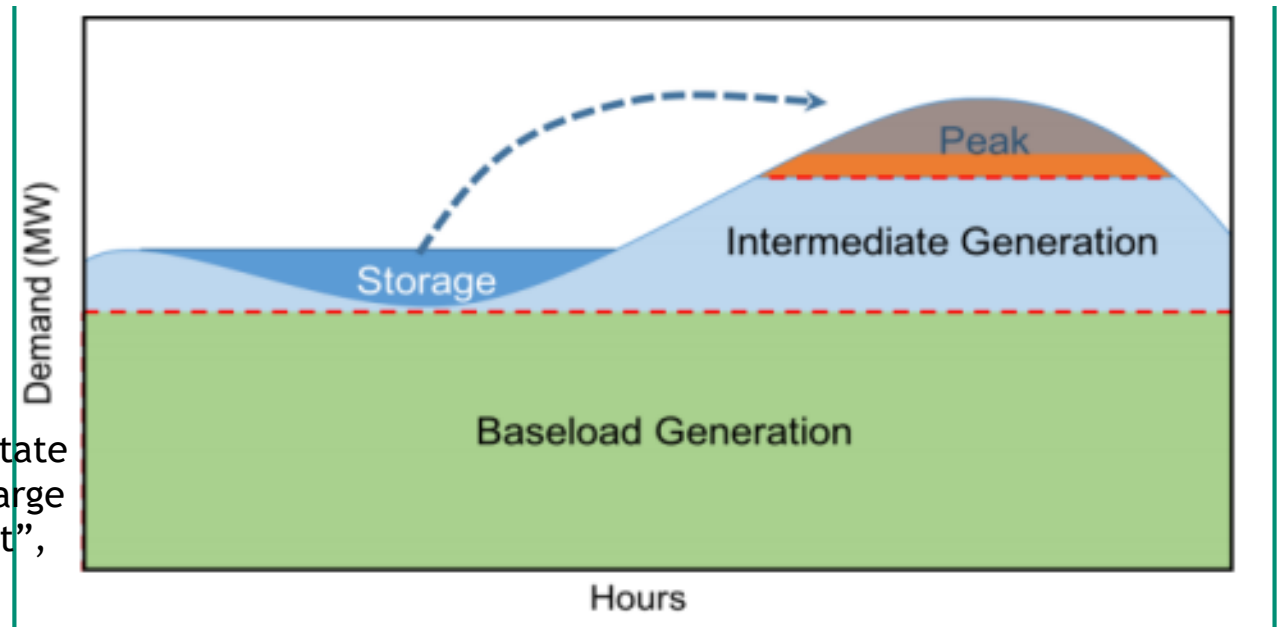
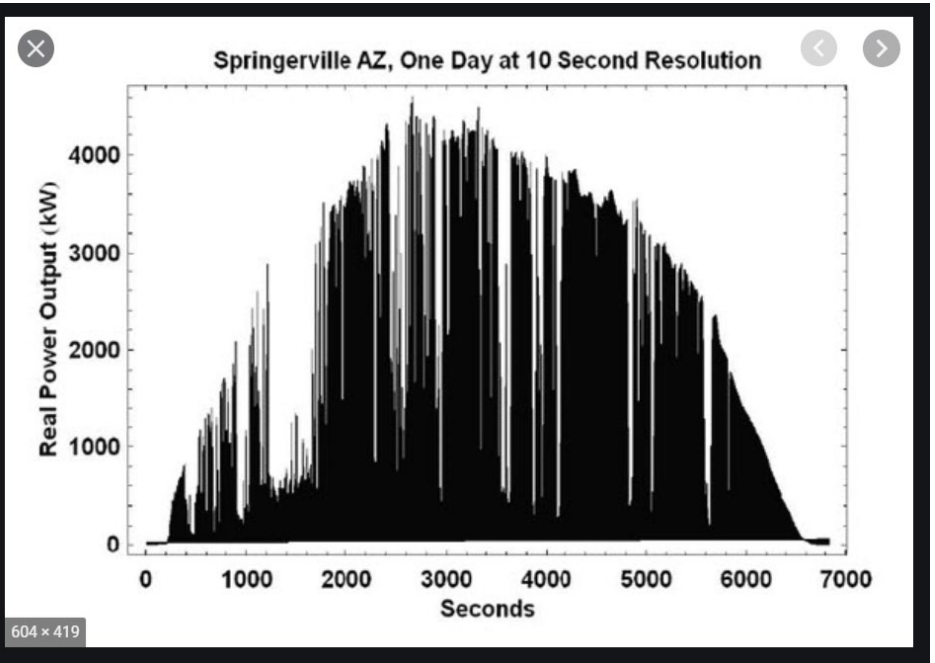
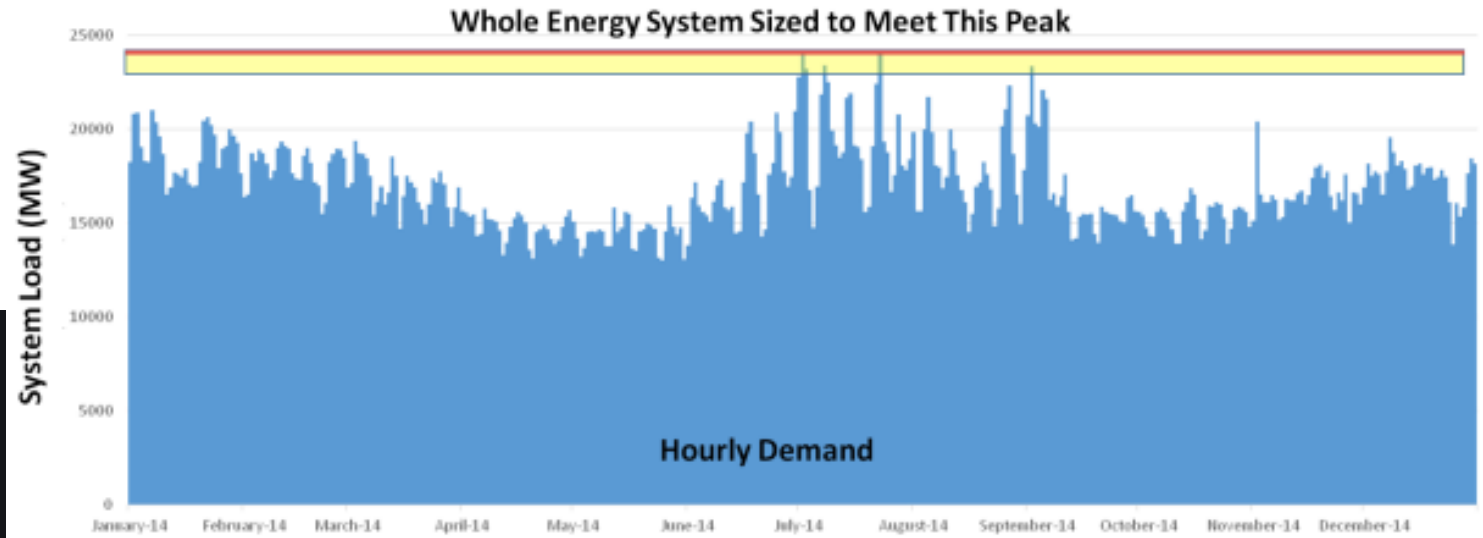

MA "State of Charge Report", 2016

ES & Decarbonization



States with 100% Decarbonization or Renewable Energy Goals

1	Arizona	100% carbon-free electricity by 2070
2	California	100% carbon-free electricity by 2045
3	Colorado	100% carbon-free electricity by 2050 for Xcel Energy
4	Connecticut	100% carbon-free electricity by 2040
5	District of Columbia	100% renewable energy by 2032
6	Hawaii	100% renewable energy by 2045
7	Illinois	100% clean energy by 2050
8	Louisiana	Net zero GHG emissions by 2050
9	Maine	100% clean energy by 2050
10	Massachusetts	Net zero GHG emissions by 2050
11	Michigan	Economy-wide carbon neutrality by 2050
12	Nevada	100% carbon-free electricity by 2050
13	New Jersey	100% carbon-free electricity by 2050
14	New Mexico	100% carbon-free electricity by 2045
15	New York	100% carbon-free electricity by 2040
16	North Carolina	Carbon neutral electricity sector by 2050
17	Oregon	GHGs 100% below 2040 baseline
18	Puerto Rico	100% renewable energy for electricity by 2050
19	Rhode Island	100% renewable energy electricity by 2030
20	Virginia	100% carbon-free electricity by 2050
21	Washington	100% zero emissions electricity by 2045
22	Wisconsin	100% carbon-free electricity by 2050

Benefits:

- **CO₂ management**
- **Ramping, balancing, and ancillary values**
- **Grid resilience and reliability**
- **New infrastructure deferral**
- **Lower utility costs & electricity rate savings**

<https://svs.gsfc.nasa.gov/4975>

Monthly global temp anomalies, 1880-2021, NASA

<https://www.cesa.org/projects/100-clean-energy-collaborative/guide/table-of-100-clean-energy-states/>

ES Definitions & Language



- Watt (W) - 1 Joule/second (~4 Joules = 1 calorie, the energy required to raise 1 gm of water 1° C)
- kW, MW, TW - a measure of maximum instantaneous generation capacity -- **POWER**
- kWh, MWh, TWh - power capacity * time -- **ENERGY**
 - 40 MW, 4 hr battery = 160 MWh; 40 MWh battery = 40MW for an hour, 20 MW for 2 hours, etc.
- **Cost** -- \$/kWh, \$/kW for cells, packs, systems, installations . . . (LCOE - lifetime cost/lifetime production . . .)
- Duration - 2 hr, 4 hr . . . (Long duration ES is increasingly important)
- Cycles - the number of times a storage device can be charged and discharged
- Depth of discharge - the depth to which discharge occurs relative to capacity
- Energy density - a ratio, energy:mass
- Round trip efficiency -- energy losses in each round trip cycle
- Parasitic loads and balance of plant - air conditioning, safety systems, rent, lawyers . . .
- Lifetime - how long a battery will perform within specs (guaranteed?)
- Recycling, circular economy, energy equity

Energy Storage “Technologies”



The ones we don't always count . . .

Carbohydrate

Fossil Fuels

Hydropower

Atoms

Gravity

Pumped Hydro

Rail cars

Vaults (towers)

Electrochemical Batteries

Lead Acid,
Lithium Ion,
Sulfur, Nickel,
Zinc, and
many more

Supercapacitors

Electrochemical Fuel Cells

Flow Batteries --
Vanadium, Zinc-
Bromine, Iron-
Chromium,
and others

Hydrogen

Mechanical

Compressed Air
Energy Storage
(CAES)

Flywheel

Thermal

Concentrating
Solar Power
(CSP)

Ice or chilled
water

Thermochemical
Energy Storage
(TCES)

Energy Storage Technologies

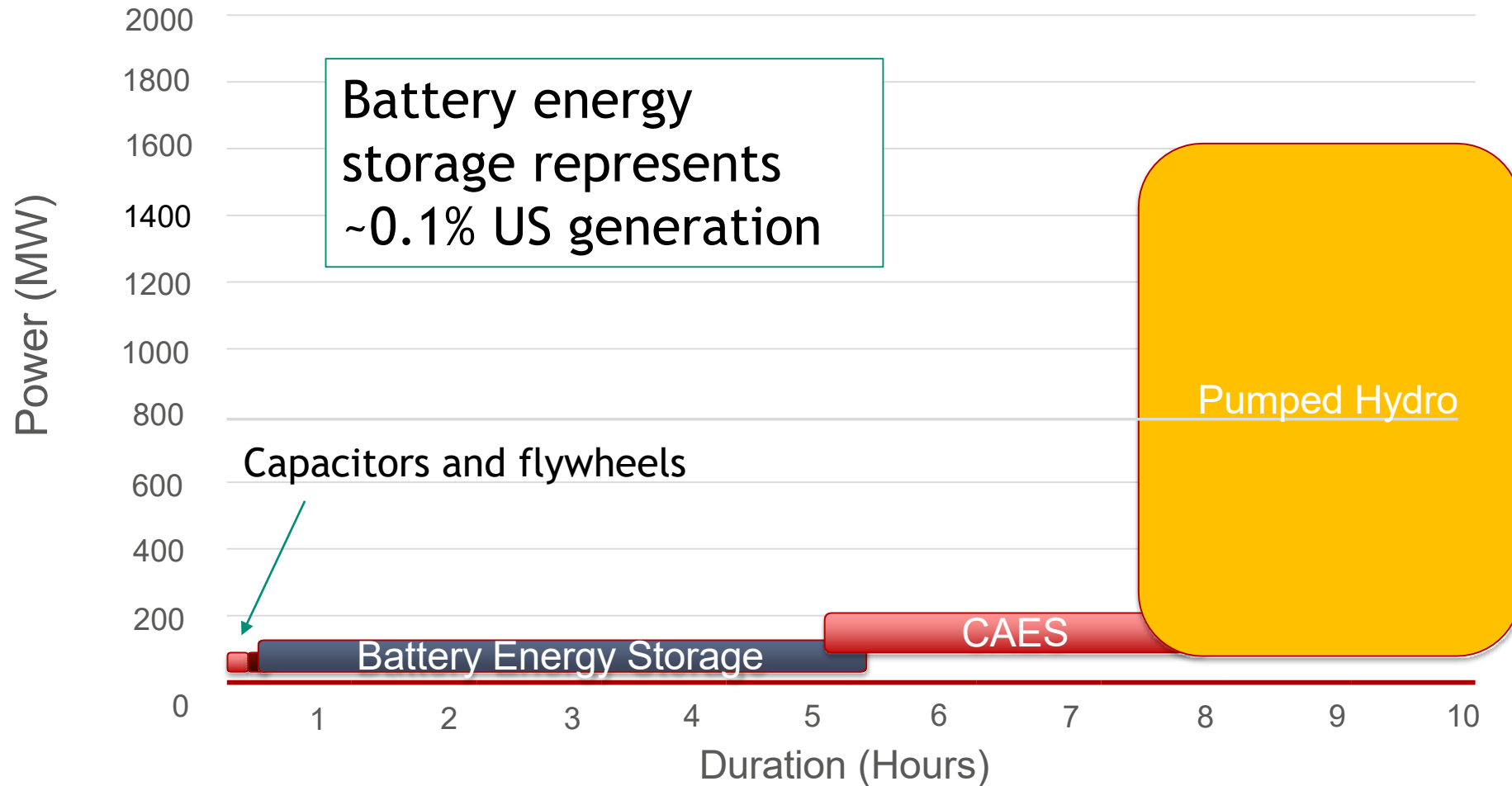

Gravity -- Pumped Hydro

- Largest global and US ES capacity (95%)
- Potentially long duration (6h to 22h)
- High power capacity (GWs)
- Mature technology
- 70-80% round trip efficiency
- Long Life (40-60 years)
- Broad applications
- Low energy density
- Slower response (seconds to minutes)
- High initial costs ($\sim \$1600/\text{kW}$ at 100 MW*)
- Tough to site new projects in the US

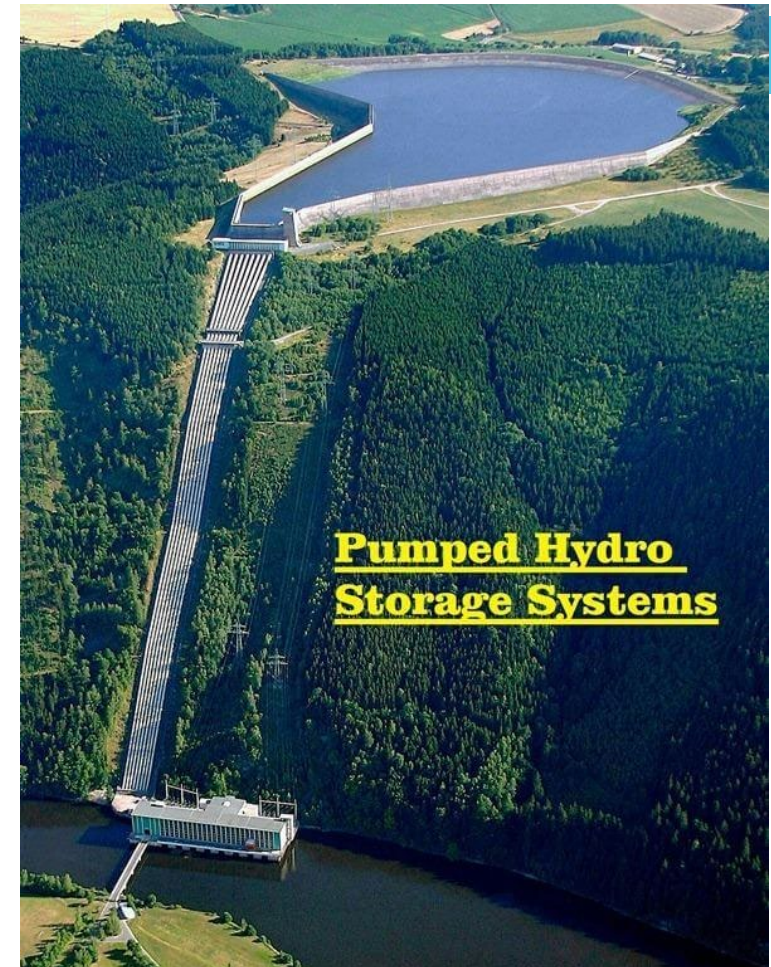

[Racoon Mountain --
https://www.windpowerengineering.com/pumped-
hydro-storage-market-to-surpass-350-billion-by-2024/](https://www.windpowerengineering.com/pumped-hydro-storage-market-to-surpass-350-billion-by-2024/)

*Costs and some other data source: R. Baxter, 1019. 2018 Energy Storage Pricing Survey. Sandia Report SAND2019-14896.

Gravity – Rail Cars & Vaults storage

- Long duration storage
- High capital costs
 - (\$1-2M/MW)
- Long cycle life
 - High maintenance costs

Vault Energy Storage



Energy Vault

Rail Energy Storage

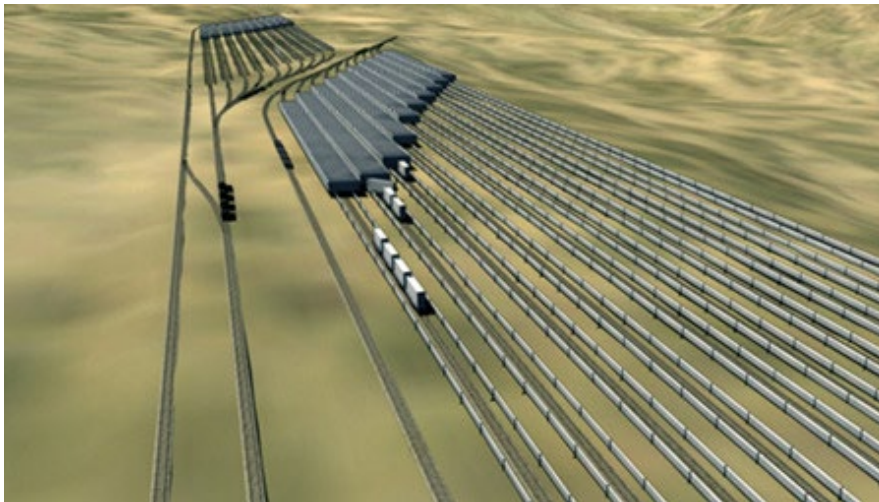

<https://www.aresnorthamerica.com/grid-scale-energy-storage>

Distribution of long duration ES technologies

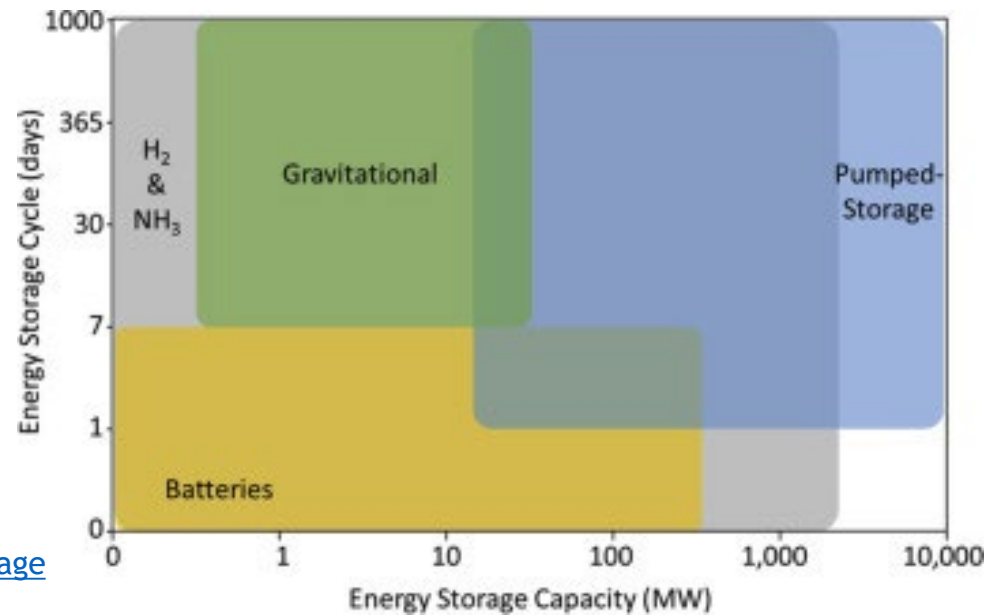

Mechanical -- Compressed Air (CAES)

- Only 3 large-scale in the world – Germany (1) & U.S. (2)
- Potentially long duration (2h – 30h)
- High power capacity (100s MW)
- Long life (40 years)
- Many efforts at small scale applications
- Broad applications
- Low roundtrip efficiency (50 -- 80%)
- Low energy density
- Slower response (seconds)
- High initial and ongoing costs ($\sim \$1500/\text{kWh}$ at 100 MW)
- Must be sited above geological repository (e.g., deep salt caverns)

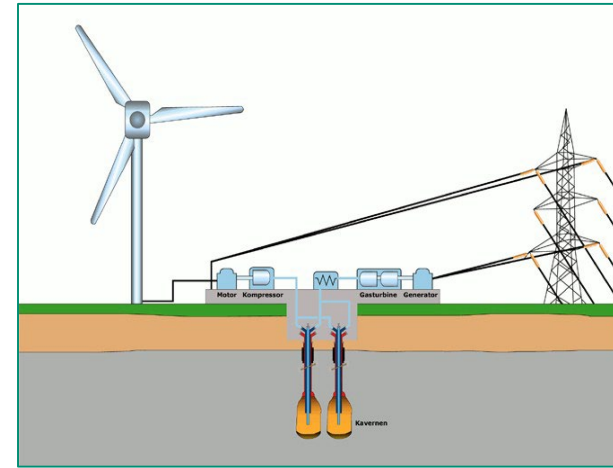

https://www.uigmbh.de/images/referenzen/CAES_animiert.gif

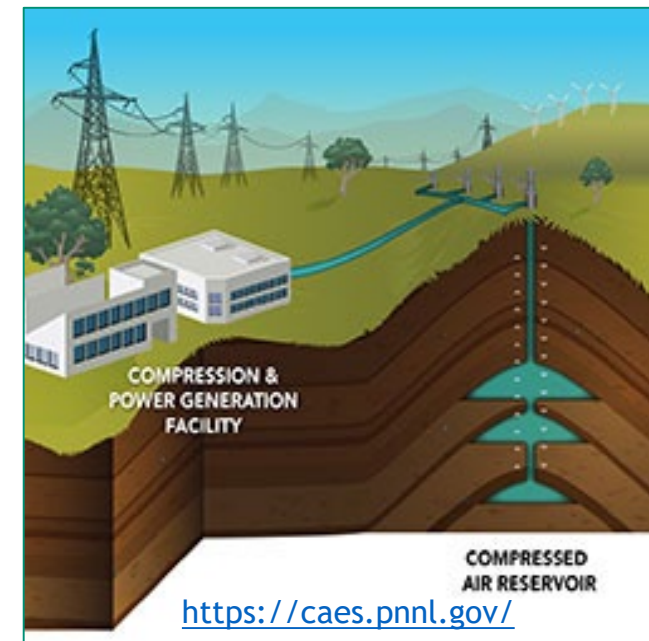

<https://caes.pnnl.gov/>

Mechanical -- Flywheels

- High power capacity (MWs with banks of flywheels)
- High cycle life (millions)
- Very fast response (milliseconds)
- 80% round trip efficiency
- Broadly applied at many scales (potters wheels, steam engines, cars, large scale ES)
- Short term storage with limited grid applications (frequency and voltage regulation, transient stability, stopping and starting electric trains)
- Relatively expensive ($\sim \$700/\text{kWh}$ at 10 MW)

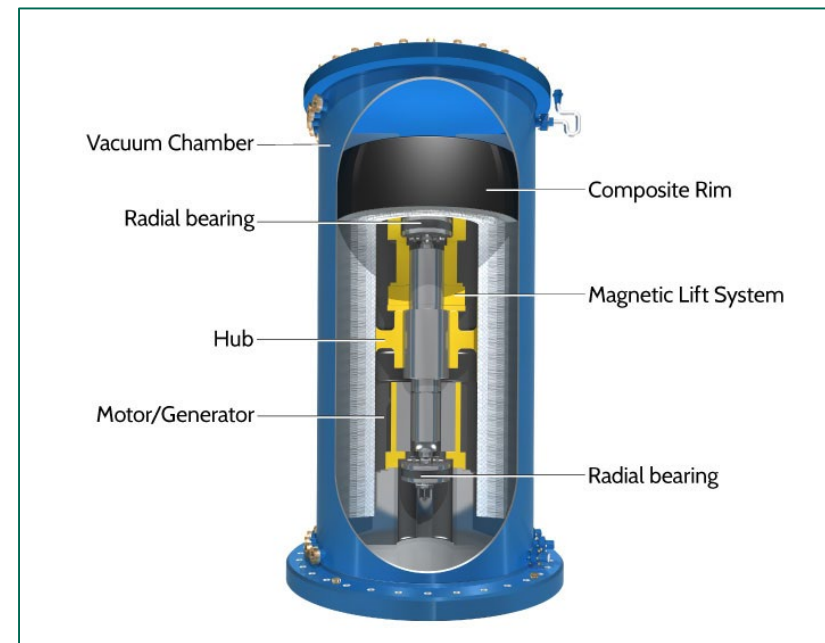

<https://beaconpower.com/carbon-fiber-flywheels/>



20 MW Frequency Regulation Plant, Hazle, PA

<https://beaconpower.com/hazle-township-pennsylvania/>

Thermal -- Concentrated Solar Power



- Mirrors concentrate solar energy on a receiver -- towers & troughs
- Molten salts store thermal energy
- High power, 3-10 hour, with long duration potential
- Low round trip efficiency (~40%), and hot!
- Lots of other thermal apps in R&D

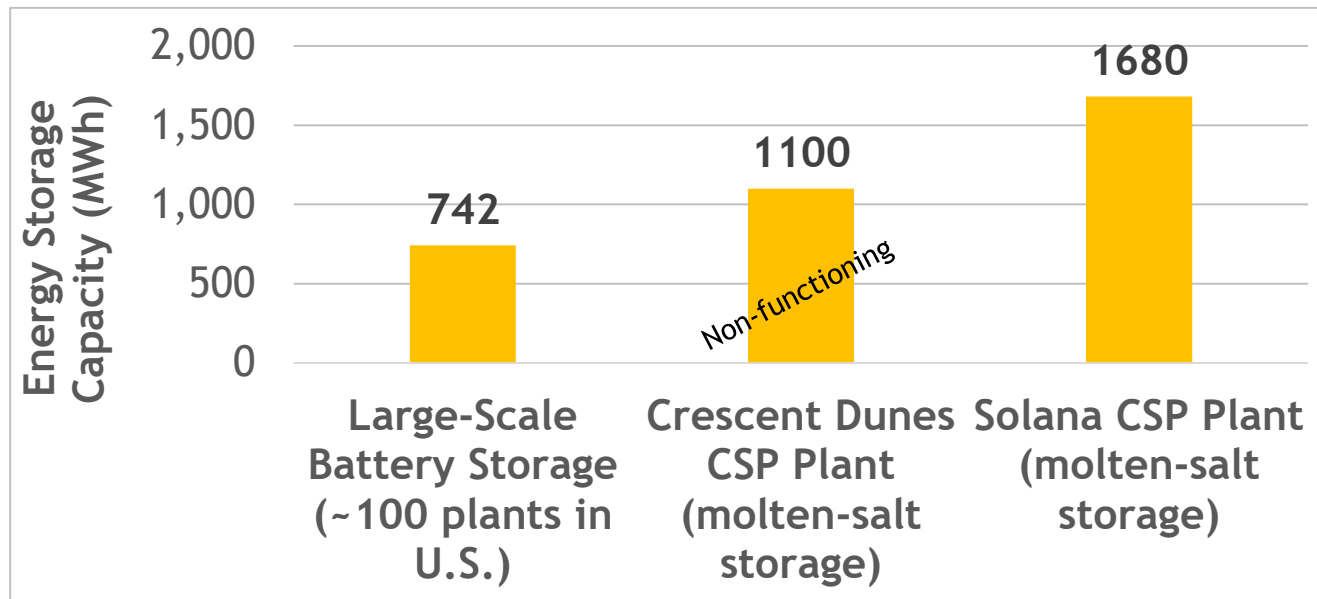

Battery data from
USEIA, 2018

CSP data from Cliff Ho,
Sandia National Labs



Thermal – ES for Cooling Buildings



- Freeze water at night when energy prices are low
- Use ice to cool air in HVAC system when energy prices are high

Thermal Battery Systems



<http://www.calmac.com/thermal-battery-systems#main>

Super Capacitors



- Electrochemical . . .
- Long life (5-10 years)
- High cycle life (thousands to millions)
- Fast discharge (milliseconds)
- High round trip efficiency (95%)
- Broad applications – regenerative braking, laptops, photographic flashes cordless tools, defibrillators . . .
- No heavy metals
- Potential to replace Li-ion
- High cost
- Low energy density
- Limited grid applications (power quality, frequency regulation)



Ultra capacitor module, designed for vehicle applications (e.g., buses, trains)



Green Hydrogen

- Use curtailed wind or PV to separate H₂ and O by hydrolysis
- Store H₂ under pressure underground or in tanks
- Burn with natural gas in combined cycle gas turbines
- Intermountain Power Plant, Utah, plans 100% conversion

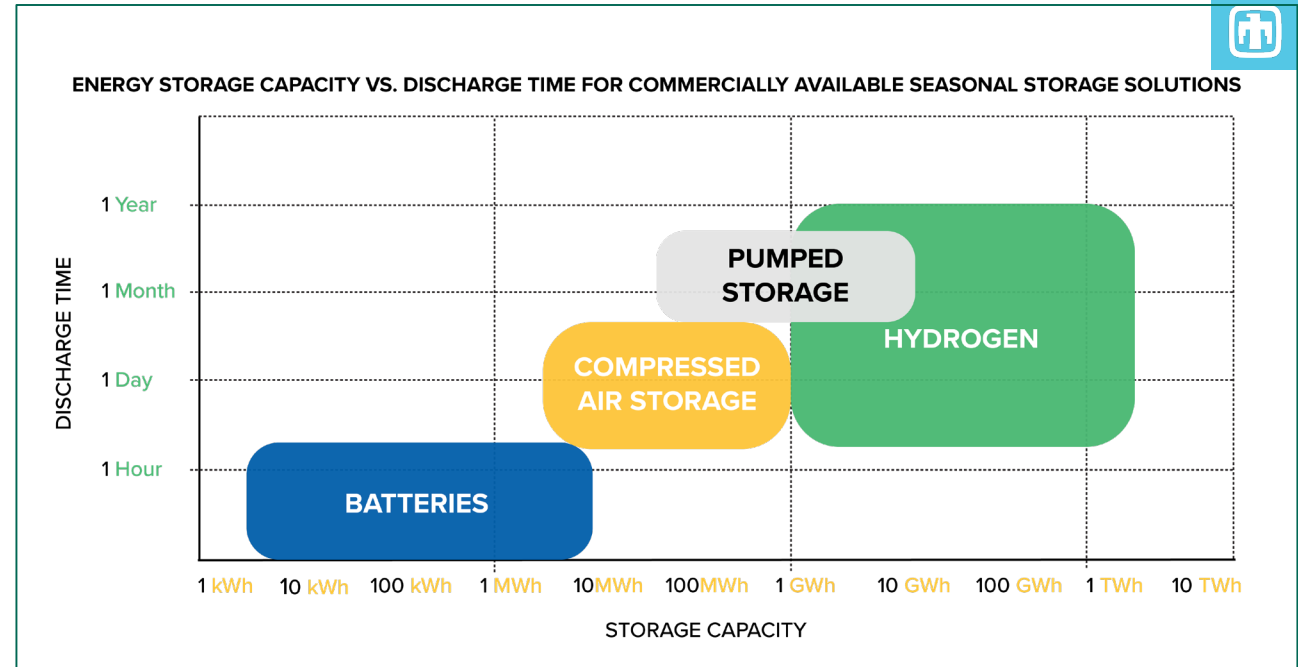

All images courtesy of Dr. Laura Nelson, Exec. Dir. of the Green Hydrogen Coalition

lnelson@ghcoalition.org

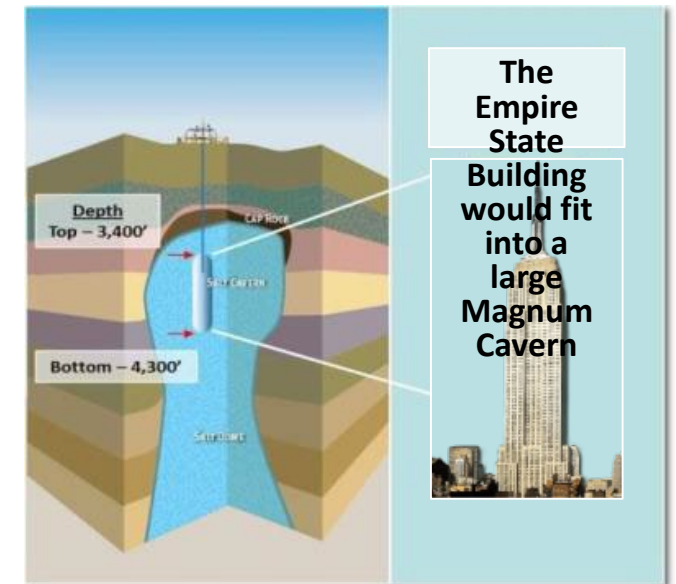

Electrochemical Batteries -- How they work



- Redox (reduction – oxidation) chemistry drives all biological metabolism

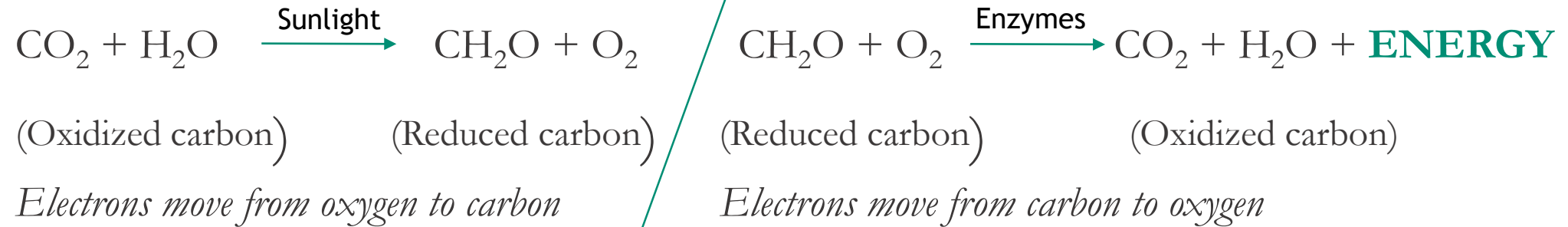

- The same redox chemistry drives battery power



Reduced lead in the presence of oxidized lead, and in a sulfuric acid electrolyte, results in lead sulfate and water, and electrons move with a force of 2 V.

Oxidation is defined as removal of electrons from an atom leading to an increase in its positive charge, and reduction as addition of electrons resulting in a decrease (reduction) in positive charge.

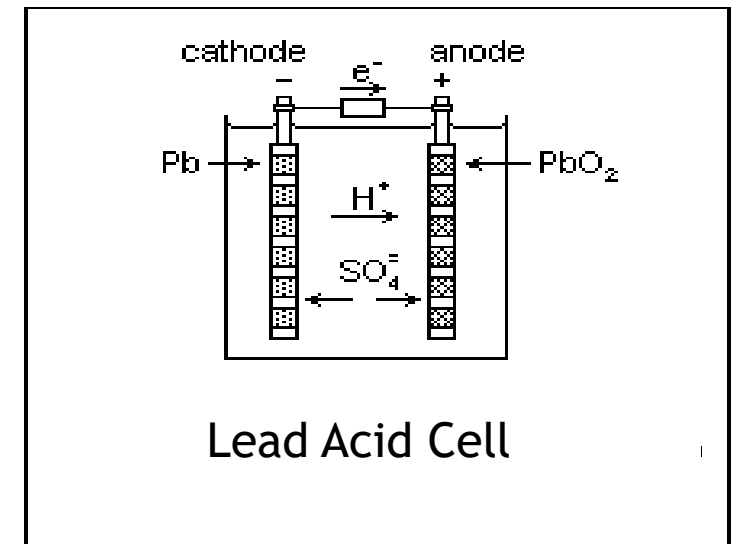

Battery costs are dropping fast



Lithium-ion battery price survey results: Volume-weighted average

Battery pack price (real 2019 \$/kWh)

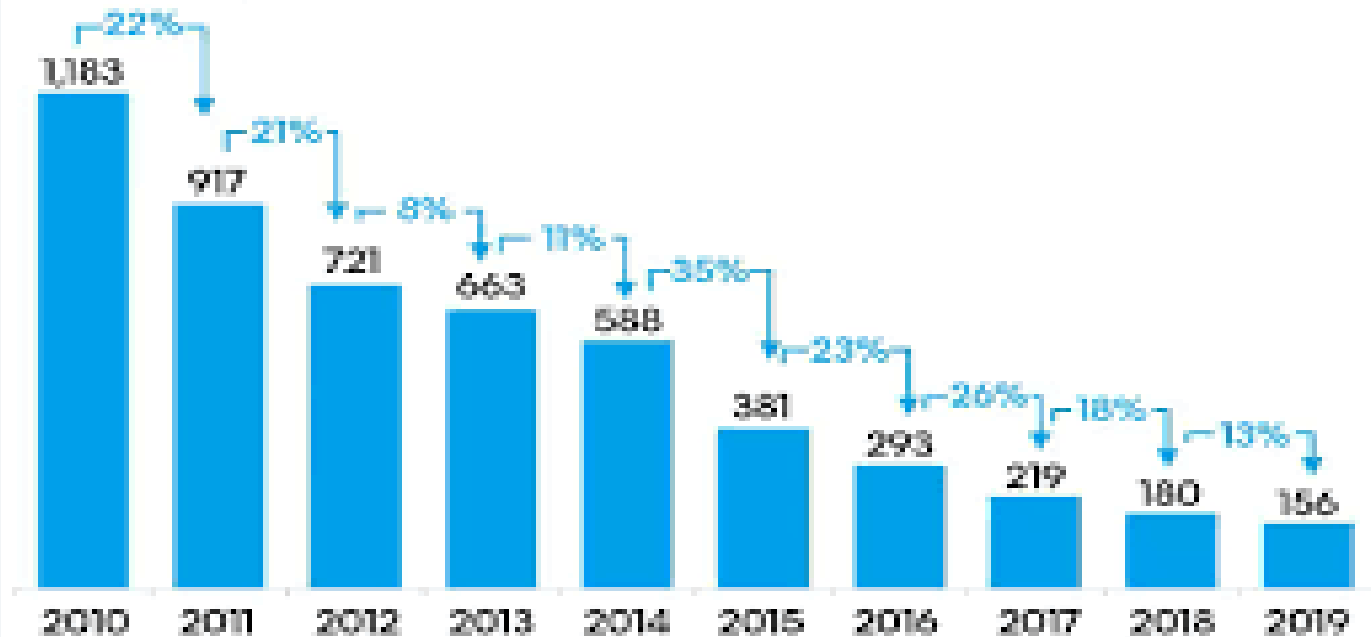

S&P BloombergNEF

<https://insideevs.com/news/386024/bloombergnef-battery-prices-156-kwh-2019/>

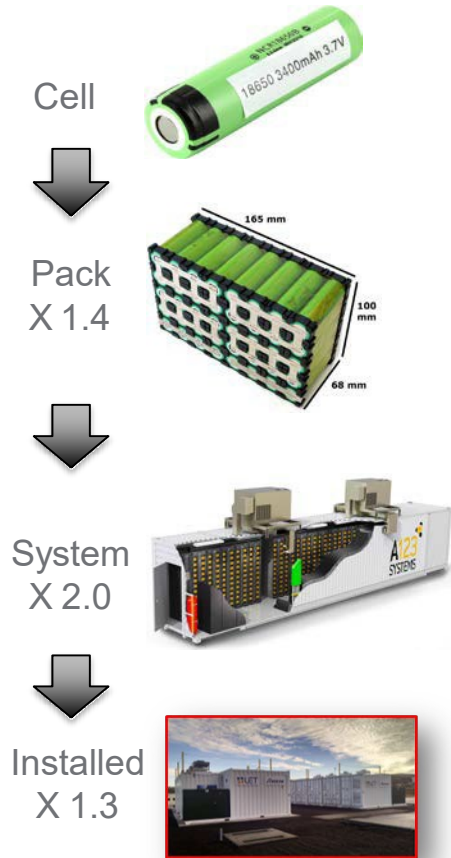

13 kWh Tesla Powerwall now sells for about \$481/kWh

\$150/kWh cell → **\$~390/kWh system**

Big savings now are not in the cells, but in the systems . . .

Global Battery Energy Storage Market Share, By Type, 2021

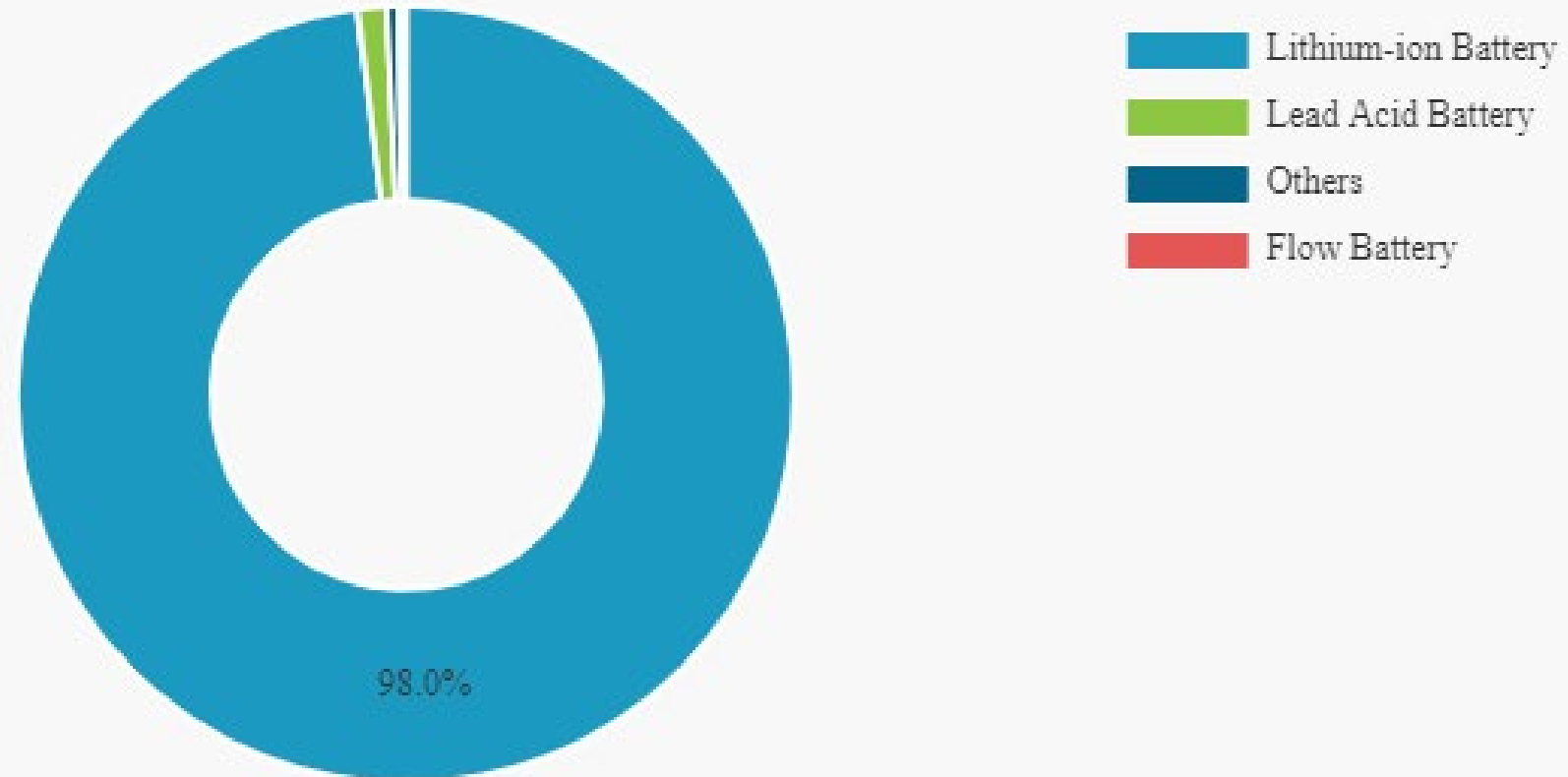

<https://www.fortunebusinessinsights.com/industry-reports/battery-energy-storage-market-100489>

Li-Ion Batteries

- High energy density
- High cycle life -- 5000-10,000 cycles at 100% DOD
- Stationary ES follows on coattails of EV battery development
- Ubiquitous – multiple vendors
- Fast response (milliseconds)
- Broad applications
- Round trip efficiency ~80-85%
- Lifespan 10-15 yrs
- Safety continues to be a significant concern
- Limited recycling is only recently available
- Uses non-domestic rare earth metals
- ~\$400-\$450/kWh at 100 MW) System level



SCE/Tesla 20MW - 80MWh Mira Loma Battery Facility



*18650 cell format used in
85 kWh Tesla battery*

Electrochemical Batteries – Li-ion

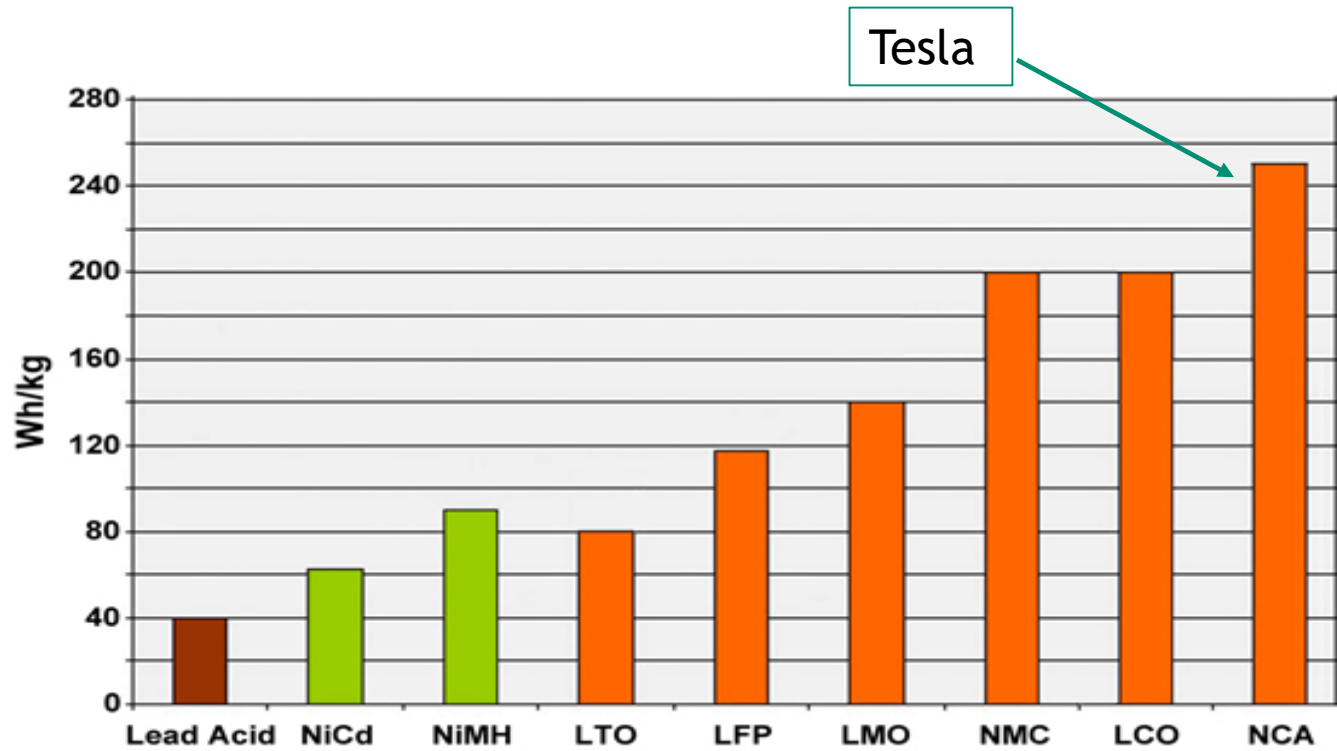

Chemistries
LiCoO ₂
LiNiO ₂
LiNi _x Co _y Mn _z O ₂
LiNi _x Co _y Al _z O ₂
LiMn ₂ O ₄
LiMn _{1.5} Ni _{0.5} O ₄
LiFePO ₄
LiMnPO ₄
LiNiPO ₄
LiCoPO ₄

iphone
Volt
Tesla

Li-Al Oxide (NCA) enjoys the highest specific energy; however, Li-Mn Oxide (NMC) and Li-phosphate (LFP) are superior in terms of specific power and thermal stability. Li-titanate, LTO) has the best life span.

Electrochemical Batteries -- Tesla and the 18650 Li-ion cell



Tesla Model S Battery Pack

7104 cells



*18650 cell format used in
85 kWh Tesla battery*



*An ESS like the 20
mW – 80 mWh
Mira Loma System
would require 6.7
million of the
18650 cells*

Electrochemical Batteries -- Sodium-Sulfur (Na-S)

- High energy density
- Life cycles
 - 2500 at 100% DOD
 - 4500 at 80% DOD
- Lifespan ~ 15 years
- Fast response (milliseconds)
- 75% round trip efficiencies
- Must be kept hot!
 - 300 - 350° C
 - Stand by losses are high, battery has to keep running or be heated up
- Longer term -- 4-6 hours
- Broad applications
- Low production volumes prevent economies of scale
- ~\$380/kWh at 100MW

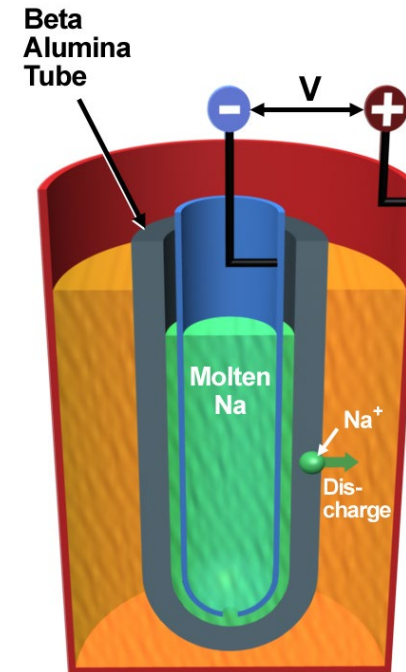
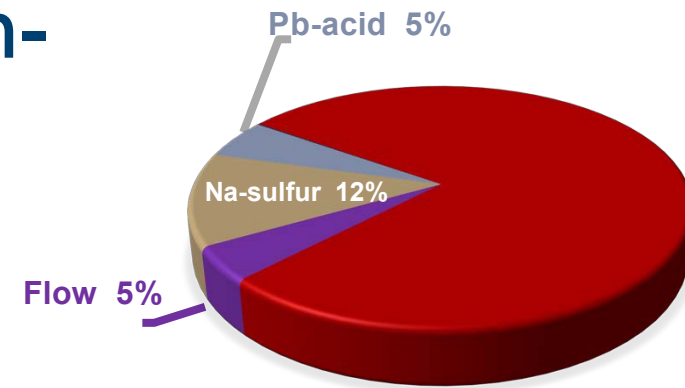

Electrochemical Batteries -- Lead Acid



- The most common batteries worldwide
- Life time ~5 yrs
- Limited cycle life --500~1000 cycles
- Round trip efficiency ~80%
- Degradation w/ deep discharge (>50% DOD)
- Low energy density (30-50 Wh/kg)
- Overcharging leads to H₂ evolution
- Sulfation occurs with prolonged storage
- Recyclable
- New lead-carbon systems (“advanced lead acid”) can exceed 5,000 cycles
- ~\$400/kWh at 1 MW

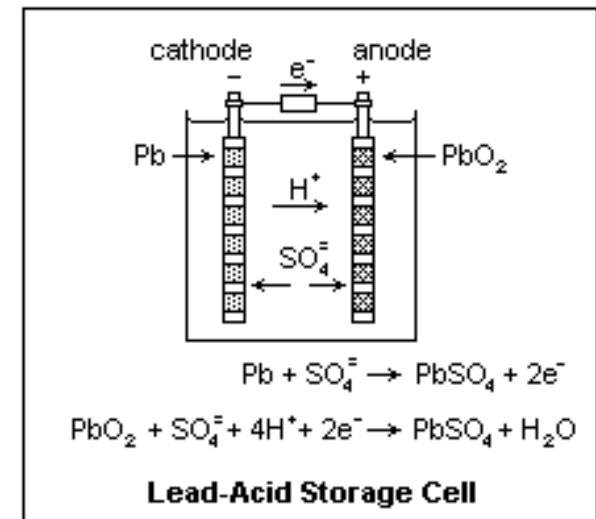
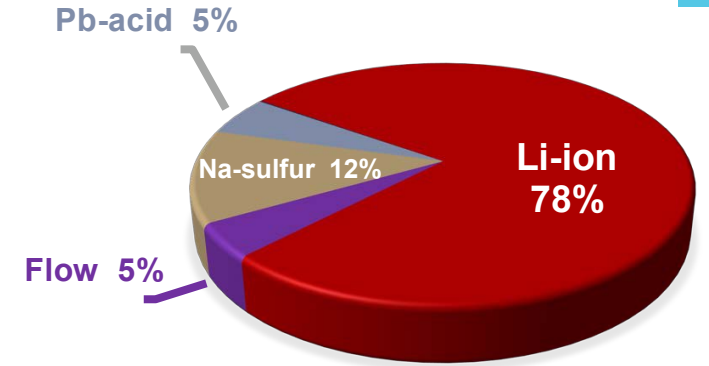

Electrochemical Batteries -- Zn-MnO_2

- Traditionally primary batteries, and ubiquitous
- Lowest bill of materials costs and manufacturing capital expenses
- Established supply chain for high volume
- Readily be produced in larger form factors for grid applications
- No temperature limitations of Li-ion or Pb-acid
- Round trip efficiency $\sim 75\%$, lifespan ~ 10 years
- Environmentally benign -- EPA certified for landfill disposal
- $\sim \$250/\text{kWh}$ at 100MW --- but projected delivered costs at $\$50/\text{kWh}$
- Reversibility has been challenging
- Cycle life must be improved



Electrochemical Fuel Cells -- Flow Batteries



- Wide range of chemistries available – Vanadium, zinc bromine, iron chromium
- Flexible -- increase volume of tanks to increase energy (no new racks, no new controllers)
- Suitable for wide range of applications, 5 kW to 10s MW
- Tens of thousands of cycles, and high duration (10 -- 20 hours)
- Safer
- Low energy density
- Lower round trip energy efficiency (70 – 80%)
- ~\$410/kWh at 100 MW

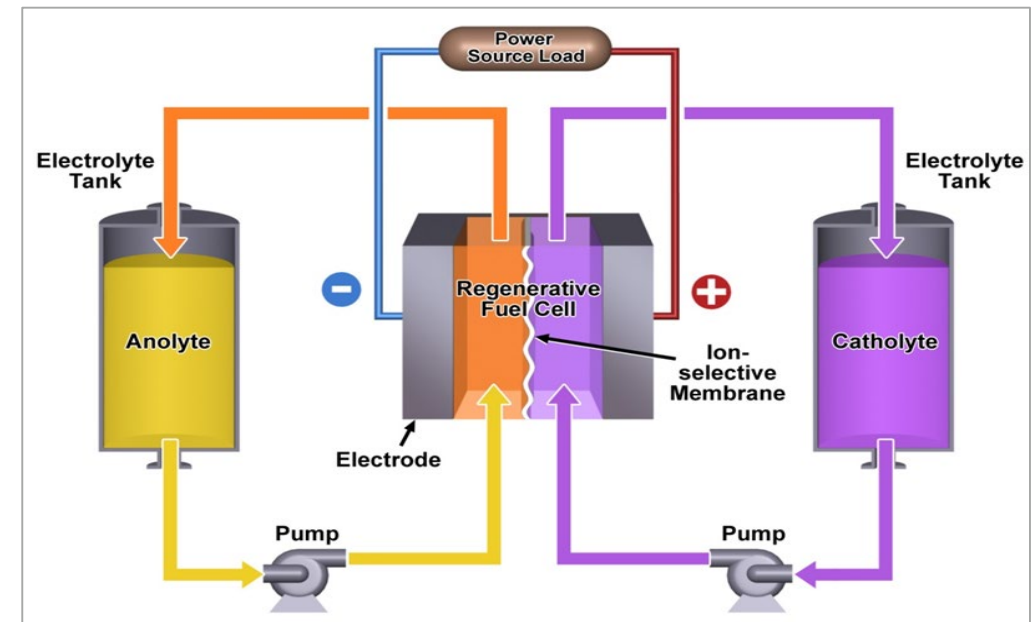
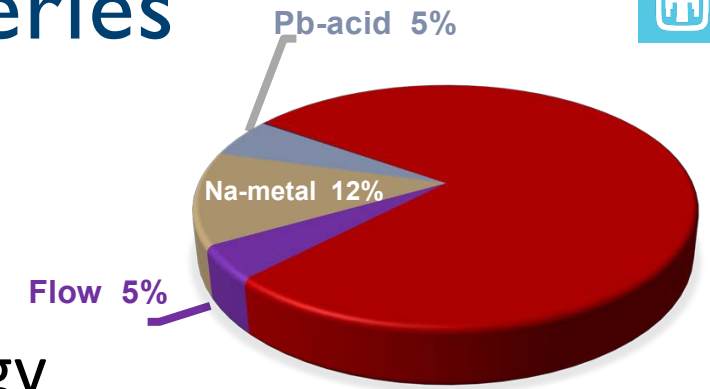

Electrochemical Fuel Cells -- Hydrogen



- Electricity splits H_2O into H_2 and O
- H_2 is stored in above-ground steel tanks, with engines, or in underground caverns
- Fuel cell uses redox chemistry to produce electricity
- Waste product is H_2O
- About as efficient as ICE
- Many applications

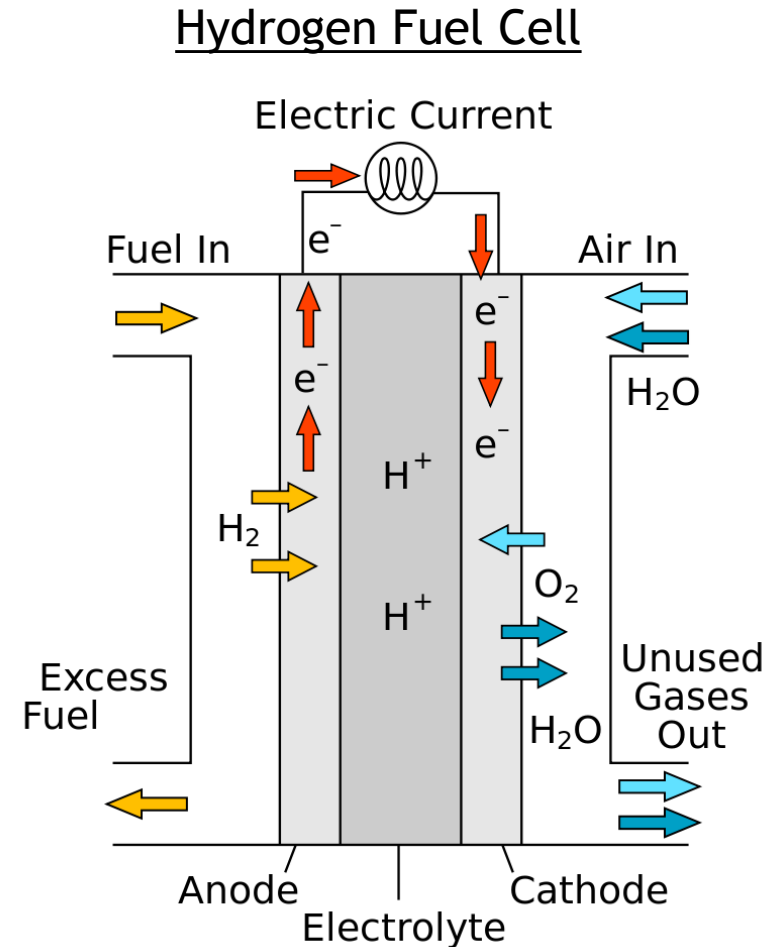

By R.Dervisoglu - Own work, based on
http://en.wikipedia.org/wiki/File:Solid_oxide_fuel_cell.svg, Public Domain,
<https://commons.wikimedia.org/w/index.php?curid=19314043>

Battery Energy Storage Systems (BESSs)



Battery Storage	Battery Management System (BMS)	Power Conversion System (PCS)	Energy Management System (EMS)	Site Management System (SMS)	Balance of Plant
<ul style="list-style-type: none"> Batteries Racks 	<ul style="list-style-type: none"> Mgmt. of the battery <ul style="list-style-type: none"> --Efficiency --Depth of Discharge (DOD) --Cycle life 	<ul style="list-style-type: none"> DC to AC, AC to DC <ul style="list-style-type: none"> --Bi-directional Inverter --Transformer, switchgear 	<ul style="list-style-type: none"> Optimal monitoring and dispatch for different purposes <ul style="list-style-type: none"> --Charge/discharge --Load management --Ramp rate control --Ancillary services Coordinates multiple systems 	<ul style="list-style-type: none"> Distributed Energy Resources (DER) control Interconnection with grid Islanding and microgrid control 	<ul style="list-style-type: none"> Housing HVAC Wiring Climate control Fire protection Permits Personnel



NOTE: Important to have single entity responsible for the ESS integration.

Whole system installation can increase costs by 2-5x over cost of a cell.

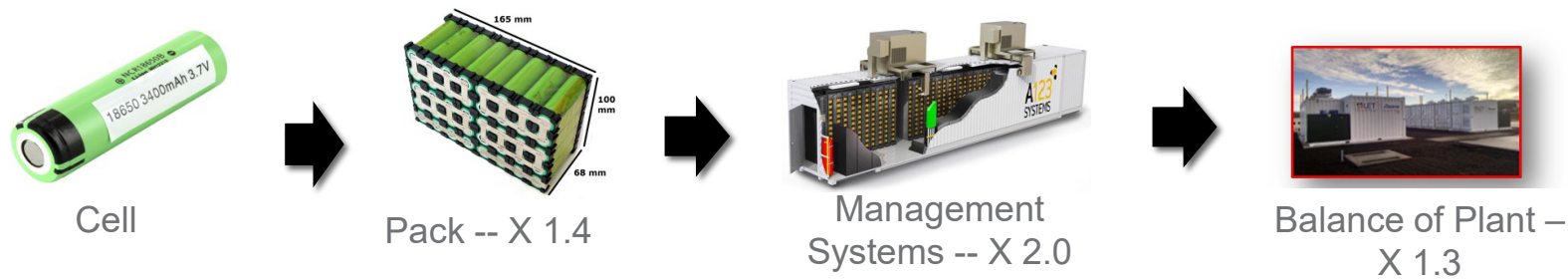

And there are many other topics ...



- Policy shapes the landscape
 - Procurement targets, incentives, RPSs, interconnection standards, etc.
- Economics
 - Energy storage applications & revenue streams
 - Stacking benefits
 - Modeling
- Finance
- Design and commissioning
- Safety
- Decommissioning/end of life



Many resources are available



DOE Energy Storage Systems Website
<https://sandia.gov/ess-ssl/gesdb/public/>

DOE Global Energy Storage Database
<https://www.energystorageexchange.org/>

Clean Energy States Alliance (CESA) <https://www.CESA.org>

Energy Storage Technology Advancement Partnership
<https://www.cesa.org/projects/energy-storage-technology-advancement-partnership/> AND <https://www.cesa.org/webinars/>

Clean Energy Group Webinars
<https://www.cleangroup.org/webinars/>

Utility Dive
<https://www.utilitydive.com/>

Energy Storage Association
<https://energystorage.org/>

The Energy Transition Show
<https://xenetwork.org/ets/>

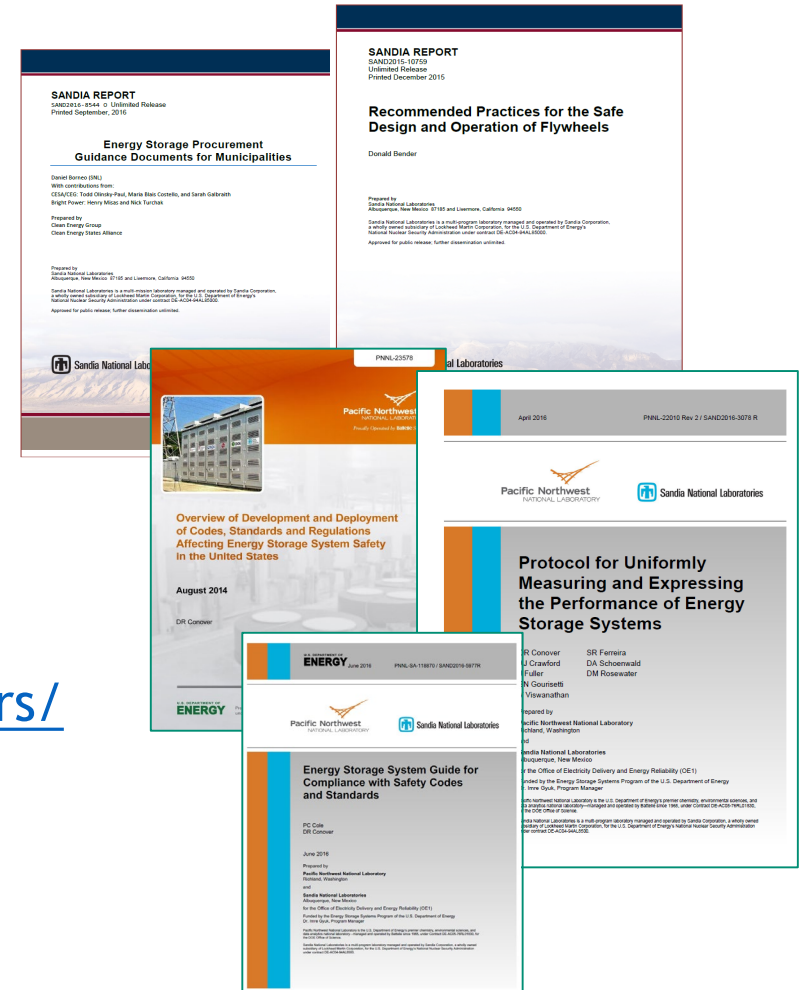

Acknowledgements



This work was supported by management and staff in the Sandia National Labs Energy Storage Systems Program,
and by
Dr. Imre Gyuk, Manager of the DOE Energy Storage Program.

Howard Passell - hdpasse@sandia.gov - 505 284-6469



U.S. DEPARTMENT OF
ENERGY





Closing points



- Battery technology is improving, spreading, getting cheaper, getting safer, and is expected to boom
- MUCH more battery capacity with longer durations is required to meet 100% carbon free goals and across the country
- Supply chain, toxicity, waste, end of life issues, recycling, cradle to cradle design, all still nascent
- Li-ion overwhelms the market, but many other chemistries and technologies are in development
- Batteries can provide important services to the grid, and many of value streams, but some of those values are hard to quantify, and markets don't exist
- PV + batteries is already outcompeting new and existing gas peaker plants

The “energy transition” is happening now

If you were in a shipwreck and a piano top came floating by, you might climb up on top of it and use it as a life preserver. But if you were in the business of designing life preservers, you probably would not make one in the shape of a piano top.

Buckminster Fuller, Operating Manual for Spaceship Earth, 1969

Climate crisis

Declining costs for renewables

Public Health

Geopolitics

Ecosystem Health



Energy dynamics are fundamentally different

- Demand is flat or declining -- little demand for new generation
- “Decarbonization” and “electrification” are on the rise
- Coal is phasing out
- PV + storage is supplanting old and new gas peakers
- Curtailment is on the rise
- Wholesale and retail markets are shifting
- 100-year-old electricity business model is history

The job of regulatory commissions is more complicated than it has ever been.

Energy storage (ES) is fundamentally different



Energy storage . . .

- Is both a load and a generation source
- Facilitates demand management
- Defers new generation and transmission infrastructure
- Unleashes the power of renewables
- Provides various services and value streams
- Provides flexibility, resilience, and reliability



Applications Served by U.S. Large Scale BESSs (2018)

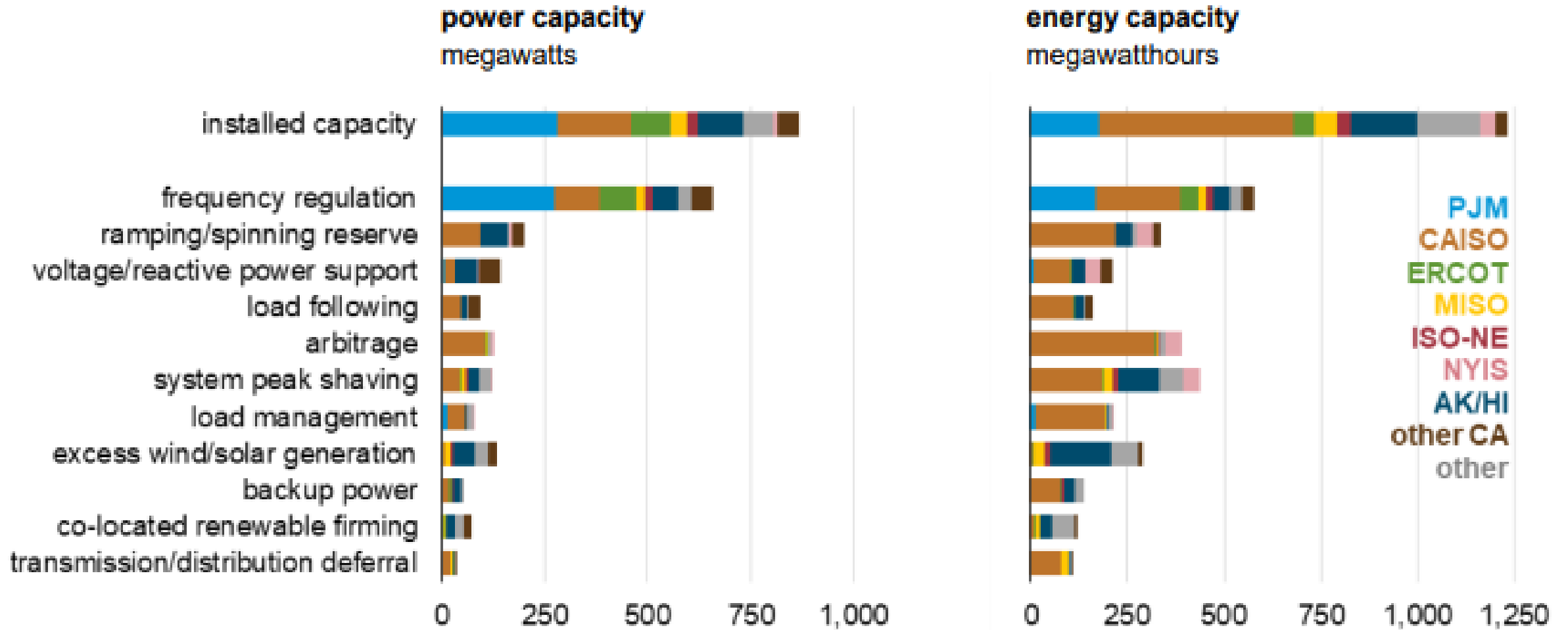

Source: U.S. Energy Information Administration, Form EIA-860, *Annual Electric Generator Report*

U.S. Battery Deployments, 2013 - 2020



Wood Mackenzie P&R/ESA | U.S. energy storage monitor 2020 year in review

woodmac.com

U.S. market deployed 2,156 MWh in Q4 2020

Quarterly MWh deployment totals dwarf the scale of previous quarters, revealing exponential growth

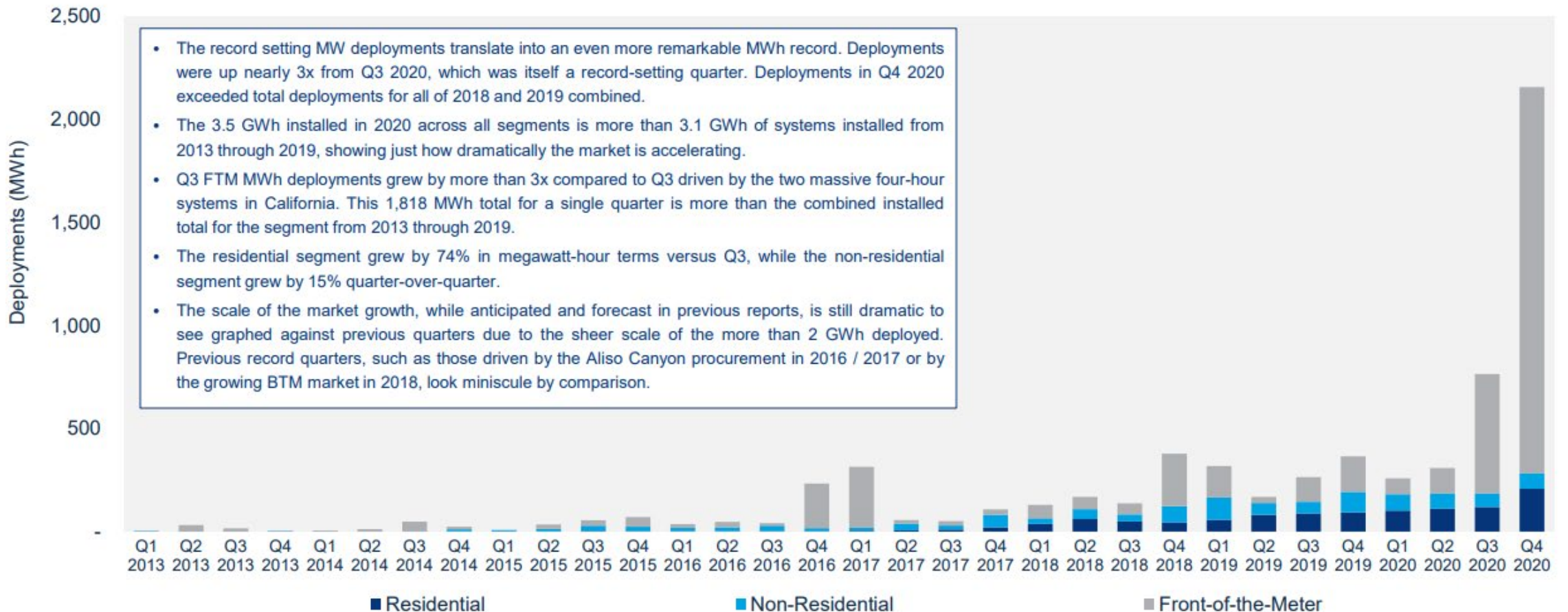

ES Projected Growth to 2025



Wood Mackenzie P&R/ESA | U.S. energy storage monitor 2020 year in review

woodmac.com 

U.S. energy storage deployments will reach 7.8 GW annually in 2025

Annual front-of-the-meter systems will make up approximately three quarters of annual deployments in 2025

U.S. energy storage annual deployment forecast, 2012-2025E (MW)



Grid-scale BES (~1.3 GW) is only ~ 0.1% of U.S. grid capacity (1300 GW) USEIA 2020